

**OUBER<sup>®</sup>**

# PORTABLE EVAPORATIVE AIR COOLER

NewTech Coolers by Fanmaster

## INSTRUCTION MANUAL

MODEL NO: PACIMD



We reserve all rights of this manual.  
We reserve the right to change or modify this manual without prior notice.



**TO PREVENT SERIOUS INJURY, READ  
AND UNDERSTAND ALL WARNINGS  
AND INSTRUCTIONS BEFORE USE.**

# CONTENTS

- 1. Safety notice ..... 1
- 2. Product introduction ..... 2
- 3. Note in use ..... 3-4
- 4. Scope of application ..... 5
- 5. Environment of use ..... 5
- 6. Packing list ..... 5
- 7. Specification ..... 6
- 8. Wiring diagram ..... 6
- 9. Diagram structure ..... 7
- 10. Parts list ..... 7
- 11. Control panel & remote intro ..... 8
- 12. Operating instructions ..... 9
- 13. Cleaning & maintenance ..... 10-11
- 14. Storage ..... 11
- 15. Troubleshoot ..... 12
- 16. Warranty ..... 13

## 16. Warranty

Any claim under this warranty must be made within 12 months of the date of purchase of the product. This warranty is limited to repair or replacement if found defective. Please note that our 12 month warranty does not extend to products which have been altered, abused, not used in an environment that the product was not designed to operate in or not used according to instructions. This includes unauthorised service or repair.

To make a claim under the warranty, take the product (with proof of purchase) to the store where you purchased the product or contact Fanmaster Pty Ltd. Fanmaster Pty Ltd will pay your reasonable, direct expenses of claiming under this warranty. You may submit details and proof of your expense claim to Fanmaster Pty Ltd for consideration.

This warranty is given by Fanmaster Pty Ltd  
 ABN: 45 353 934 457  
 Unit 1/6-8 Yalgar Rd, KIRRAWEE NSW 2232  
 P: 02 9524 9999  
 E: info@fanmaster.com.au

This warranty is provided in addition to other rights and remedies you have under law: Our goods come with guarantees which cannot be excluded under the Australian Consumer Law. You are entitled to replacement or refund for a major failure and to compensation for other reasonably foreseeable loss or damage. You are also entitled to have the goods repaired or replaced if the goods fail to be of acceptable quality and the failure does not amount to a major failure.

### 15. Troubleshoot

Failure phenomenon	Possible causes	Solution
Unable to turn on	1. No Power connection 2. Switch failure 3. Phase failure 4. Low voltage	1. Check power supply 2. Replace switch 3. Check phase 4. Check voltage
Excessive noise	1. Fan blade dirty, deformed or damaged 2. Motor wear 3. There are sundries blocking the outlet	1. Change fan blade or adjust bracket 2. Replace motor 3. Clear the sundries
Fuse burnt out	1. Water pump damage 2. Synchronous motor damage	1. Replace water pump 2. Replace synchronous motor
Water leakage	1. Machine on an unbalanced surface 2. Leaking from the tank 3. Drainage valve damage 4. Water inlet damage 5. Water level is too high 6. Water distribution system is damaged 7. Cooling pads are dirty	1. Move the machine to an even surface 2. Repair or replace tank 3. Replace drainage valve 4. Replace the water inlet 5. Adjust the float valve 6. Check or replace the water distribution system 7. Clean the cooling pads
No air supply	1. Cooling pad or filter is blocked 2. Control panel is damaged 3. Mainboard is damaged 4. Fan button doesn't work 5. Motor phase	1. Clean or replace the cooling pad and filter 2. Replace the control panel 3. Replace the circuit board 4. Check the motor 5. Check the phase
No cooling	1. Shortage of water 2. Water level system failure 3. Water pump damaged 4. Cool button doesn't work 5. Mainboard is damaged	1. Check water levels, add water to tank 2. Replace water level sensor 3. Replace water pump 4. Replace control panel 5. Replace circuit board
Water tank and filter screen with precipitation	1. High control mineral in water supply	1. Increase drainage frequency
Malfunction code: 01 02 03 04 05 06 07 08	1. Over current protection 2. Communication failure 3. Input over voltage 4. Input under voltage 5. UV overload 6. Swing overload 7. Water pump overload 8. Draining overload	1. Check the voltage & motor, check if cooling pad or filter blocked. 2. Check if signal line is connected 3. Check voltage 4. Check voltage 5. Check if UV lamp is damaged 6. Check synchronous motor 7. Check if water pump damaged 8. Check if the draining pump is damaged

### 1. Safety Notice

1. Do not put unnecessary things/objects into the air outlet as this will cause damage to the fan and could lead to injury.
2. Do not climb up or stack things on the unit. Do not let children or infirm persons near or operate the fan.
3. Do not place burning apparatus near the fan as it may cause carbon monoxide poisoning. Precautions must be taken to avoid the back-flow of gases into the open fire of gas or other fuel-burning appliances.
4. Do not attempt to make any modifications to or repair the product yourself. Have it installed or repaired by a qualified person only.
5. Do not place the unit where there is flammable and explosive gas.
6. If this machine will be not used for a long period of time, turn off the water supply and drain all the water out of the water tank and then run the fan function only to completely dry the cooling pads.
6. This unit must have a reliable earth wire connection. If the earth wire is incorrectly connected it could cause an electric shock or fire.

## 2. Product Introduction

Evaporative air coolers uses evaporation to cool the air. In an evaporative cooler a pump circulates water from the reservoir on to a cooling pad, which in turn becomes very wet. A fan draws air from outside the unit through the damped pad. As it passes through the pad the air is cooled by evaporation.

The temperature of dry air can be dropped significantly through the phase transition of liquid water to water vapor (evaporation), which can cool air using much less energy than refrigeration systems.

“Refrigerated air conditioning consumes more energy and creates more greenhouse gases than fans and efficient evaporative cooling systems” Source: www.yourhome.gov.au

### Advantages

#### 1. Less expensive to install

Estimated cost for installation is about half that of central refrigerated air conditioning

#### 2. Less expensive to operate

Estimated cost of operation is 1/4 that of refrigerated air conditioning. Power consumption is limited to the fan and water pump. Because the water vapor is not recycled, there is no compressor that consumes most of the power in closed-cycle refrigeration. The refrigerant is water. No special refrigerants, such as ammonia, sulfur dioxide or CFCs, are used that could be toxic, expensive to replace, contribute to ozone depletion and/or be subject to stringent licensing and environmental regulations

#### 3. Ease of maintenance

The only two mechanical parts in most basic evaporative coolers are the fan motor and the water pump, both of which can be repaired at low cost and often by a mechanically inclined homeowner.

#### 4. Ventilation air

The constant and high volumetric flow rate of air through the building reduces the “age-of-air” in the building dramatically. Evaporative cooling increases humidity. In dry climates, this may improve comfort and decrease static electricity problems. The pad itself acts as a rather effective air filter when properly maintained; it is capable of removing a variety of contaminants in air, including urban ozone caused by pollution, regardless of very dry weather. Refrigeration-based cooling systems lose this ability whenever there is not enough humidity in the air to keep the evaporator wet while providing a constant trickle of condensate that washes out dissolved impurities removed from the air.

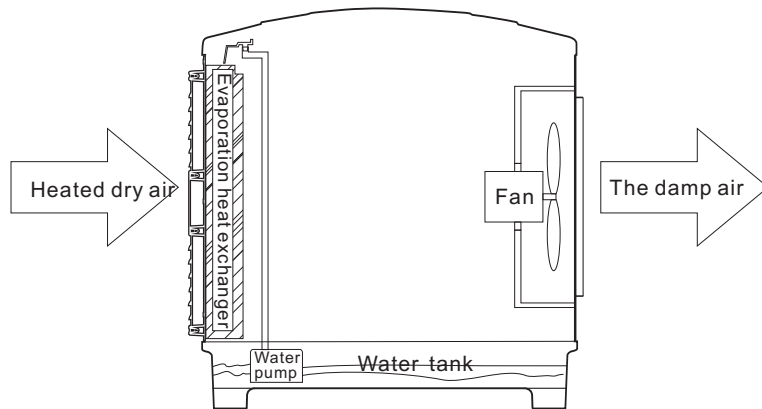

Sketch Map of Operating Principle

## CLEANING THE WATER TANK

\*PLEASE ENSURE THE UNIT IS TURNED OFF AND UNPLUGGED FROM THE POWER SOURCE

1. Open the water outlet valve(on the bottom of the machine) to drain out all the water from the tank.
2. Remove the screws from the air-inlet louvers then remove the air-inlet louvers.
3. Use a cloth or brush to wipe the inside of the tank
4. Rinse the inside of tank
5. Use a cloth to wipe the inside down

## CLEANING THE OUTSIDE OF THE MACHINE

\*PLEASE ENSURE THE UNIT IS TURNED OFF AND UNPLUGGED FROM THE POWER SOURCE

1. Use a soft cloth to wipe down the machine.

### NOTE:

**do not use detergents or solvent**

## 14. Storage

When not in use please store in a clean environment.

Please ensure the water tank is completely drained.

Please ensure the cooling pads and filters are completely dry. Run in fan mode for a minimum 10 minutes.

### 13. Cleaning & maintenance

TYPE	FREQUENCY	
Changing the water	Weekly	1
Cleaning the filter screen	Monthly	1
Cleaning the cooling pads	Quarterly	1

\*Please note in more dusty environments, the above schedule may need to occur on a more frequent basis.

#### CLEANING THE COOLING PAD AND FILTER SCREEN

\*PLEASE ENSURE THE UNIT IS TURNED OFF AND UNPLUGGED FROM THE POWER SOURCE

1. use a screwdriver to unscrew 6 screws from the air-inlet louvre as per the image.
2. pull out the filter screen from the air-inlet louvre
3. hold the cooling pad and/or the filter screen and wash it down with a hose.

**NOTE:**

**do not use a high pressure water hose as it may cause damage to the cooling pads**  
**do not use detergents or soap to clean the cooling pads**

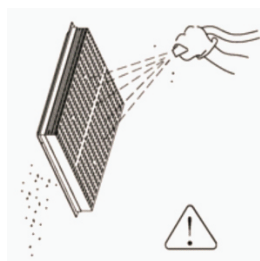

### 3. Note in use

In order to prevent harm or damage to users and other people's personal safety and property, please make sure to comply with the following:

- This symbol, referring to please be careful - "to draw attention to"
- This symbol, referring to do not do - "banned"
- This symbol, referring to the need to implement - "mandatory"

Non-authorized or non-qualified personnel are not permitted to do repair or modification to this unit!

banned

Could lead to product failure or injury

Do not use voltage expectant AC220~240V ± 10%!

banned

Could cause a fire or electric shock

Please solely use rated current of 10A socket!

When in use in combination with other electrical appliances, the power socket or board may have abnormal heat, resulting in a fire

This machine should be used with single-phase two pole grounded electrical outlet and to ensure its reliable grounding! Grounding device is not installed, it could lead to airframe and other metal parts with electrostatic induction.

Ensure grounding

Could lead to product failure or leakage

Make sure to unplug the power plug from the socket when cleaning the water tank and cooling pads, moving the machine or when not in use long periods.

May result in an electric shock or damage

Do not damage, destroy, over bend and twist the power cord. Please do not place heavy objects on the power cord. Ageing or damaged power cord must immediately be replaced or repaired by an authorised persons.







banned

Easily cause damaged, fire and electric shock

Use 0.15~0.6MPa water pressure! Temperature cannot exceed 45°C.

banned

May result in the cooling pad to dissolve and plastic product deformation, damage and affect the performance





-  This machine is to be used for indoor use.
-  Strictly prohibit the use in environments with flammable and explosive gases and to avoid long-term direct sunlight.
-  Do not place this machine on uneven or tilted surfaces as the machine may fall, causing damage to the machine body and internal parts.
-  Do not place the machine close to walls, curtains and other material as it will restrict the air intake and affect the air supply.
-  Do not tilt or use high impact force to the machine once water has been added.
-  Electrical maintenance must be completed by a qualified persons.
-  If the power cord is damaged, it must be replaced by the manufacturer, its service agent or similiary by a qualified persons in order to avoid a hazard.

Correct Disposal of this product



This marking indicates that this product should not be disposed with other household wastes throughout the EU. To prevent possible harm to the environment or human health from uncontrolled waste disposal, recycle it responsibly to promote the sustainable reuse of material resources. To return your used device, please use the return and collection systems or contact the retailer where the product was purchased. They can take this product for environmental safe recycling.

## 12. Operating instruction

1. Make sure the voltage is in accordance with the local voltage before use.
2. Connect the plug into the power source, the machine will be in standby mode. Press the ON/OFF “” button to turn on and off. Once turned off the machine will be in standby mode.
3. Once the machine is turned on, press “” to turn on the cooling mode. You will start to hear water rising and being distributed over the cooling pads, once saturated the fan will start. If there is no water the water pump will not turn on and if the water has run out the water pump will automatically turn off and the fan will continue to work.
4. For fan option only, press “”to turn on fan mode.
5. There is a water level sensor that works inline with the water float valve that controls the water level and water flooding. On the LCD screen it will show the water level bar “”, when there are no bars showing it means there is no water, a low water level alarm will go off.

## 11. Control panel & remote introduction

1. LCD screen
2. Disabled
3. Swing control
4. Fan only
5. Disabled
6. Disabled
7. Disabled
8. - Signal received
9. Increase air flow
10. Disabled
11. Cooling mode
12. ON/OFF
13. Reduce air flow
14. Disabled

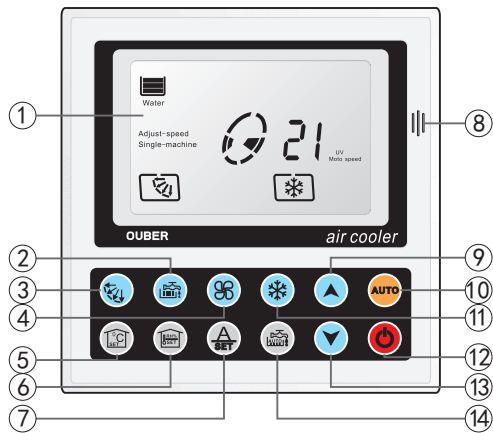

\*Please note the motor on this machine is single phase with a frequency control. The factory setting for the current is 5A, please do not change or attempt to make any adjustments as this may cause failure to the machine and will void the warranty.



LCD remote control

1. ON/OFF
2. Increase the air flow
3. Reduce the air flow
4. Cooling mode
5. Fan mode
6. Disabled
7. Control the swing
8. Disabled

8.

## 4. Scope of Application

NewTech Air Coolers have a lot of advantages from cooling, humidification, purification, ventilation and energy saving. This product is suitable for applications with open areas with adequate ventilation. High humidity areas may need assistance from an engineering design.

## 5. Environment of use

1. Ambient temperature 25°C~45°C;
2. Environment relative humidity ≤ 90%
3. Water supply should make softening treatment  
0°C < temperature of water supply < 45°C  
Pressure of water supply: 0.15-0.6MPa
4. Deviation of voltage can not be more than ± 10% of rated voltage
5. No corrosive gases
6. No inflammable and explosive gas or dust

## 6. Packing list

Number	Description	Qty
1	Cooler	1
2	Remote Control	1
3	Instruction manual	1

## 7. Specifications

Model	PACIMD
Airflow	5000 L/S
Voltage/Frequency	220V-240V/50Hz
Current	5A
Power	1.1KW
Motor IP	IPX4
Fan Type	Axial
Water tank	300L
Machine size (mm)	1080 x 1080 x 1625
Net weight	97KG
Applicable area (m2)	100~150
Air outlet dimension (mm)	290×200×8
Noise	< 70dB
Water consumption	5-20L/H
Machine IP	IPX4

## 8. Wiring diagram

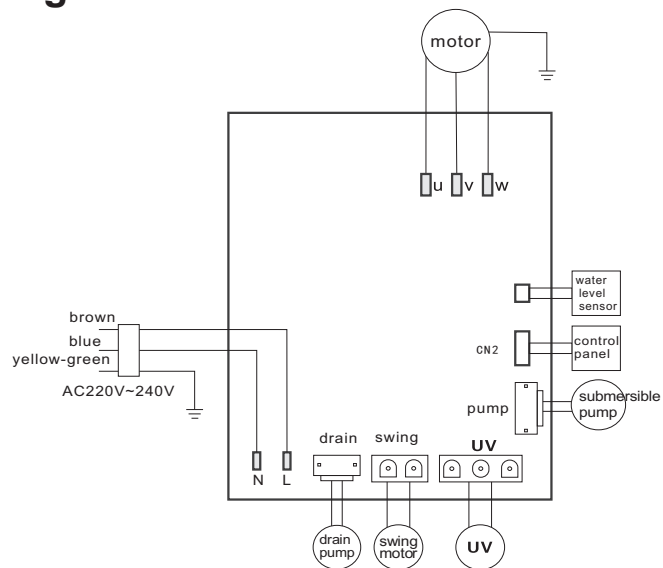

## 9. Brief diagram of structure

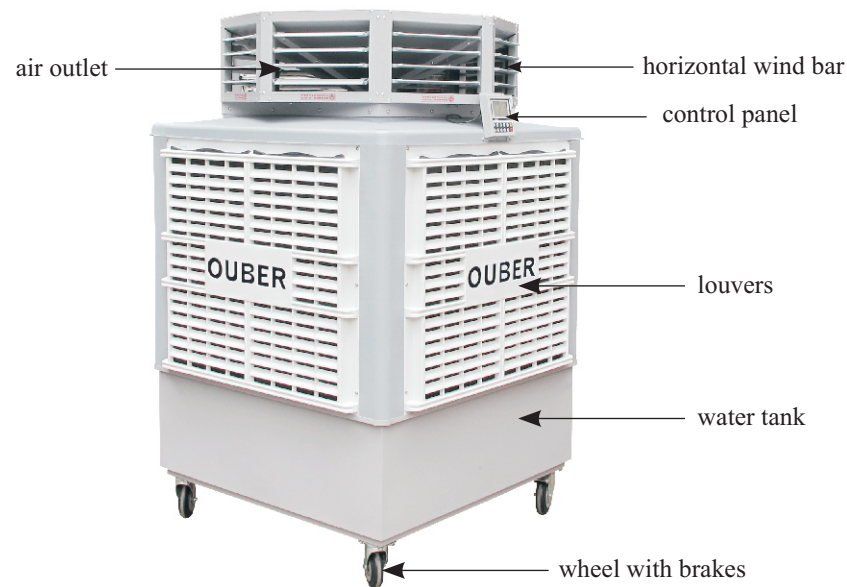

## 10. Parts list

<b>LCD Control Panel</b>
<b>Fan Motor 1.1KW</b>
<b>Water Submersible Pump</b>
<b>Synchronous motor</b>
<b>Water Float</b>
<b>Filter screen (black)</b>
<b>Cooling Pads</b>
<b>Water Level Sensor</b>
<b>Control board</b>